

10. ASSEMBLY CROSS HEAD - MODEL 9 x 7 NL

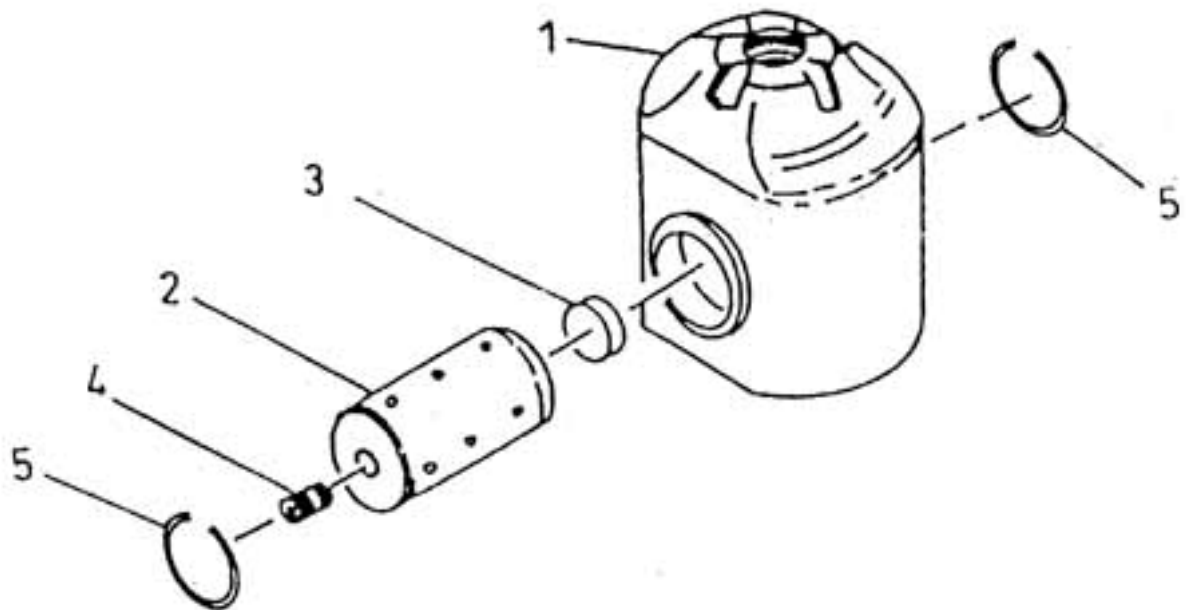

10. ASSEMBLY CROSS HEAD - MODEL 9 x 7 NL

No.	Description	Ref Part No.	QTY
1	Cross Head 7"	30559736	1
2	Pin Cross Head	90732538	1
3	Plug Crosshead Pin	30206940	1
4	Plug 1/4"	95250932	1
5	Ring Retainer	30576136IM	2